

EXPERIMENTAL INVESTIGATIONS OF A SHADED-POLE FLAT

LINEAR INDUCTION MOTOR

J.F. GIERAS

Dept. of Electrical and Electronic Engineering
University of Cape Town, Rondebosch 7700, South Africa

P. KLEINHANS, M.L. MANCHEN, and E. VOSS

School of Electrical Engineering
Cape Technicon, PO Box 652, Cape Town 8000, South Africa

ABSTRACT

A shaded-pole flat single-sided linear induction motor has been tested experimentally. Although the construction of such a motor is very simple, it has been found that the performance characteristics are rather poor in comparison with a three phase rotary induction motor and a three phase linear induction motor. Nevertheless, a shaded pole linear motor can be found in applications where a three phase power supply is not available and a simple and cheap drive is necessary.

INTRODUCTION

Current trends in the design of electrical machines are oriented towards optimizing the construction and minimizing the cost of manufacturing. The cheapest and most reliable electrical machine is an induction machine. Its construction can be simplified further by replacing the three-phase winding located in slots by a concentrated-parameter single-phase winding with auxiliary short-circuited coils. Further simplifications are: a flat stator with an open magnetic circuit, a disc-type rotor and elimination of gear boxes. Such a single-phase linear induction motor (LIM) with shaded poles is very simple, reliable and cheap.

Although thousands of research contributions to LIMs have been published so far, as far as the authors are aware, a shaded-pole LIM has never been considered.

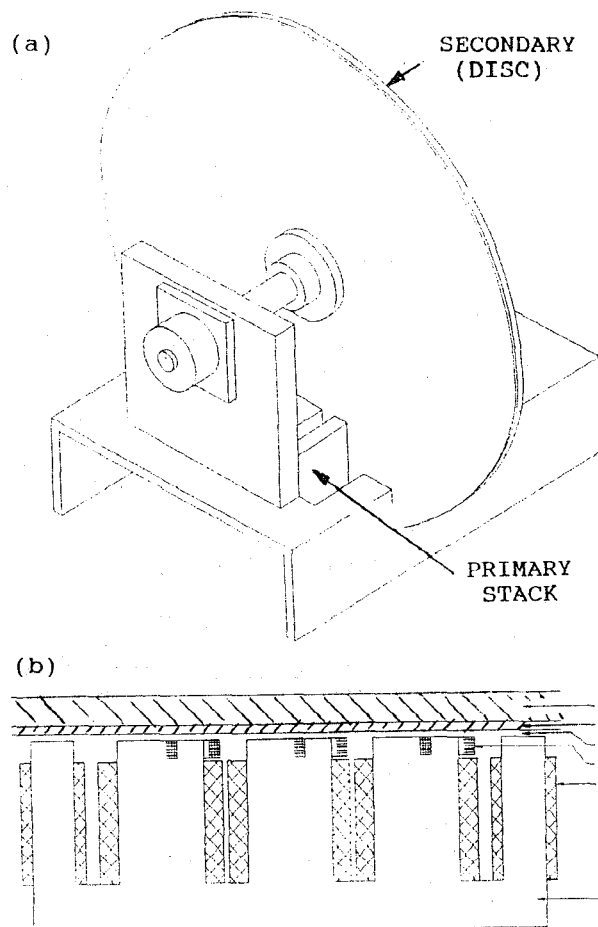

Fig. 1. Shaded-pole flat single-sided LIM: (a) general assembly; (b) structure

1 - secondary back iron; 2 - aluminum cap; 3 - airgap; 4 - short-circuited coil, 5 - main winding, 6 - primary stack.

CONSTRUCTION

Fig. 1 shows the basic construction of the shaded-pole LIM. It consists of two main parts: a flat magnetic core and a round conductive disc.

The laminated core is made of a standard 0.5-mm, non-oriented silicon steel transformer laminations. The slots have to be open as this reduces the leakage fluxes of the main and auxiliary windings. Shaded-pole copper rings fit tightly into the slots. The copper rings have been soldered in a very clean environment with a silver solder. It is important to solder the seams with material that has a high melting point to prevent disintegration during extreme operating conditions. The main winding has then been wound. The complete primary stack is then placed into an oven and heated to 160 °C, so as to obtain a homogeneous temperature throughout the core. Then the core is dipped in a special transformer resin until all air bubbles disappeared. The high temperature of

Table 1. Design data of the tested shaded-pole LIM

Dimensions	
length of core	0.09 (m)
height of core	0.064 (m)
width of core	0.192 (m)
weight of core	4.26 (kg)
weight of aluminium and mild steel disk	9.5 (kg)
diameter of aluminium and mild steel disk	0.52 (m)
thickness of aluminium cap	3 (mm)
thickness of mild steel disk	10 (mm)
diameter of secondary rotor	0.52 (m)
cross sectional area of shaded pole ring	0.0024 (m ²)
Electrical parameters	
number of phases	1
frequency	50 (Hz)
voltage	220 (V)
current	11.603 (A)
resistance	12.813 (Ω)
speed	84 (rpm)
Materials	
stator motor	single-phase shaded-pole
stator core	laminated (H18, 0.5mm, Non Orientated Silicon Steel)
rotor disk	aluminium cap laminated to mild steel disk
slot insulation	DMD-Mitron (6510)
shaded pole	copper soldered with silver solder

the core ensures that the resin in the vicinity of the core becomes thinner and is able to fill up every air gap that exists between the laminations and the windings. Finally the primary stack is baked to dry and to harden the resin.

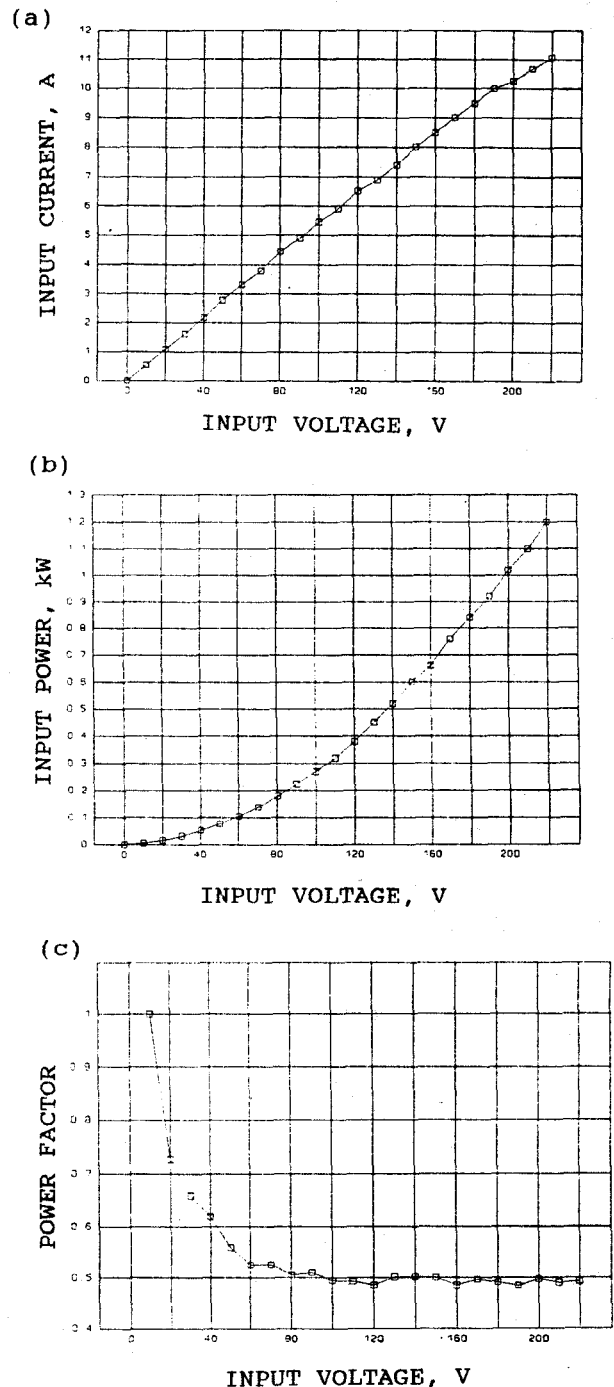

Fig. 2. No-load characteristics: (a) input current; (b) input power; (c) power factor

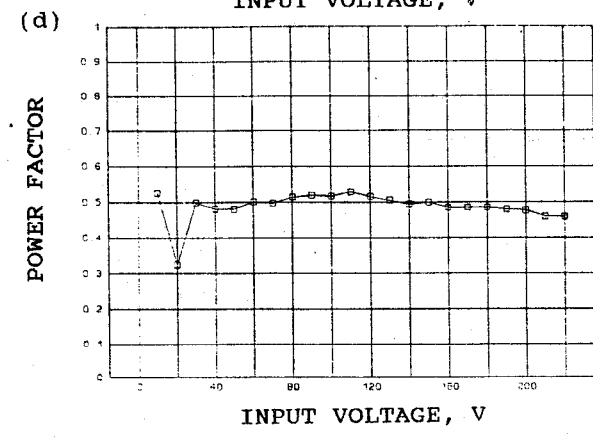
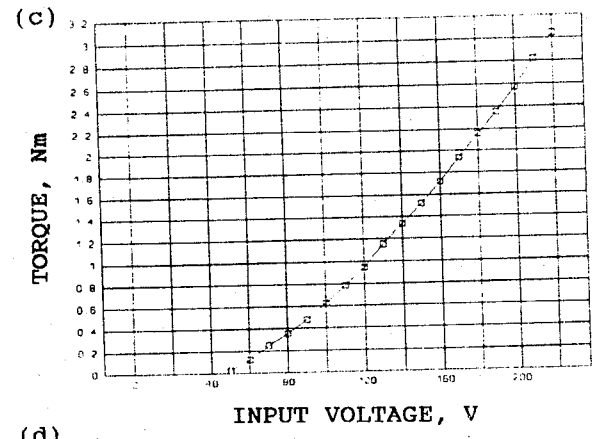
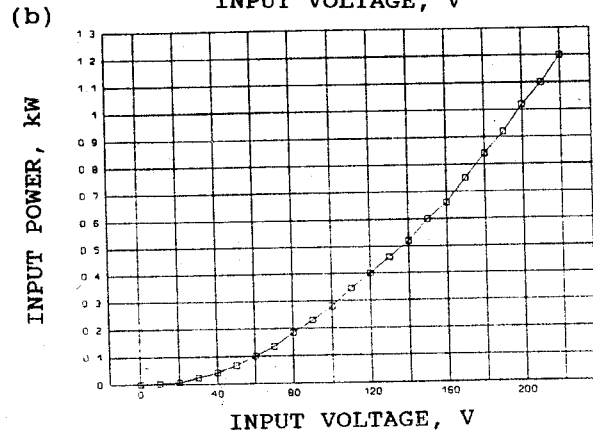
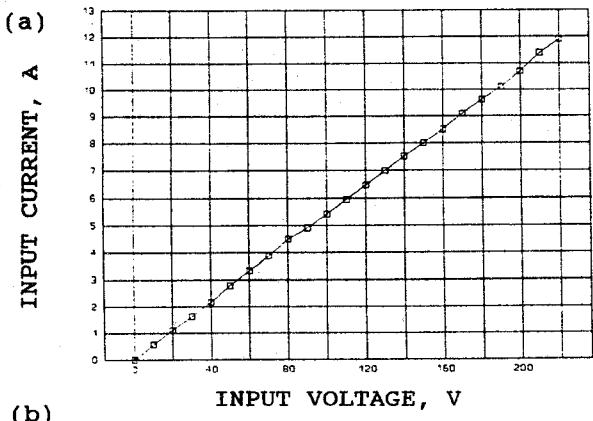

Fig. 3. Locked-rotor characteristics: (a) input current; (b) input power; (c) torque; (d) power factor.

The disc is much cheaper and easier to construct than its counterpart, the cage rotor. The disc has been made of a 10-mm mild steel plate to which a 3-mm aluminium cap has been laminated. The moment of inertia of the disc is 0.653 kgm².

The primary and the disc are mounted on a supportive structure in such a way that the airgap and the distance of the core from the centre of the disc to the edge of the disc can be changed.

The design data of the experimental machine are shown in Table 1.

TESTING

No-load test

The no-load characteristics, i.e. the input current, input power and power factor plotted against the input voltage are shown in Fig. 2.

Locked-rotor test

An adjustable scale has been connected to the disc. As the supply voltage is risen in small increments, readings of the input current (Fig. 3a), input power (Fig. 3b) and torque (Fig. 3c) have been taken. Then, the power factor (Fig. 3d) has been calculated.

Load test

A Prony's brake has been used to measure the shaft torque. The load characteristics versus speed are presented in Fig. 4.

Run-out time

The LIM has been run up to rated speed, after which the input power has been cut and the speed measured every 5 s. The speed in rpm and linear velocity in m/s are plotted against time in Fig. 5.

CONCLUSIONS

The performance characteristics show clearly that the disadvantages of a shaded-pole LIM are a low power factor, a small starting torque and a low efficiency. This is mainly due to a large airgap and the fact that the phase shift between the main and auxiliary winding is less than 90°.

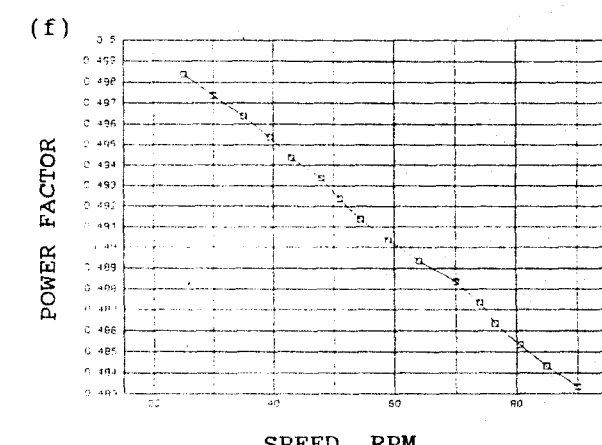
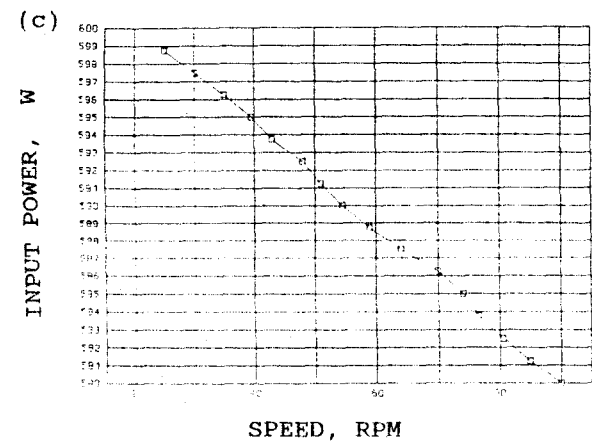
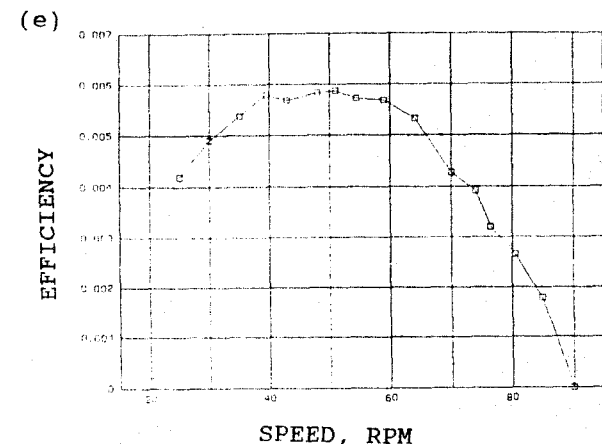
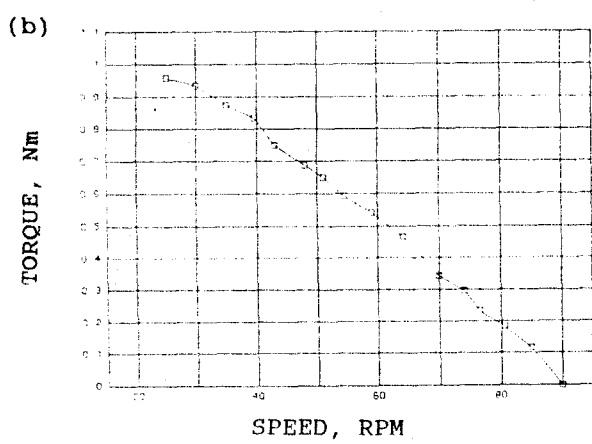
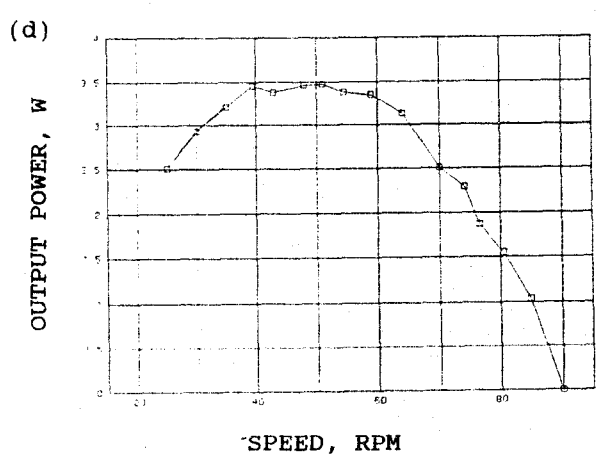
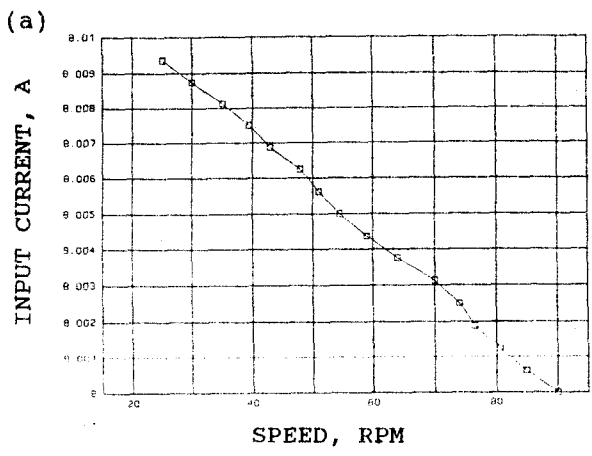

Fig. 4. Load characteristics: (a) input current; (b) torque; (c) input power; (d) output power; (e) efficiency; (f) power factor.

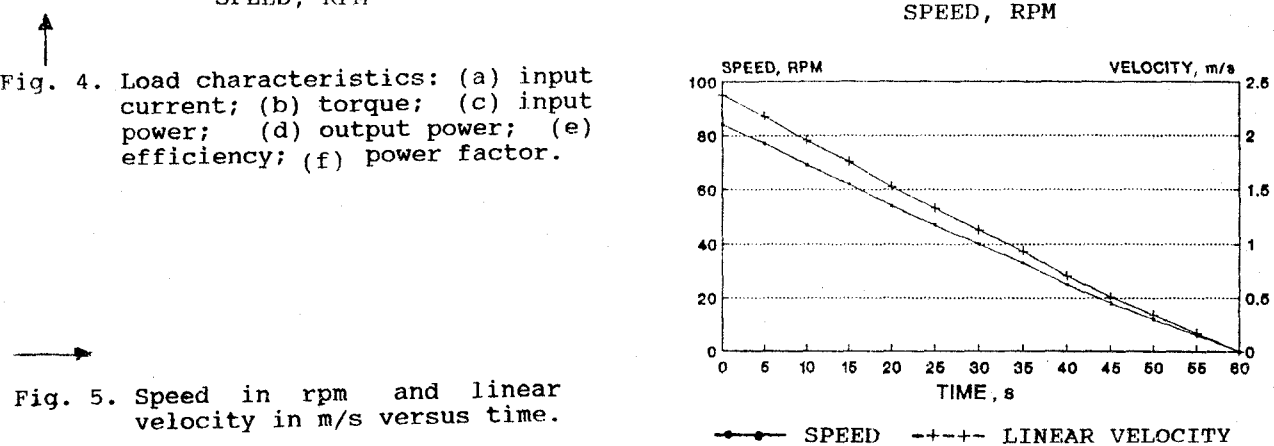

Fig. 5. Speed in rpm and linear velocity in m/s versus time.

It has been found that the distance from the core to the centre of the disc plays an important part in the performance of the LIM. The braking component of the thrust (owing to the flat primary and the curvature of the secondary) is reduced as the distance between the two is increased.

Although the efficiency, power factor and starting torque of this LIM are worse than those of an ordinary induction motor, such a LIM can find applications when a three-phase power supply is not available and the price and simplicity of the drive is important.

ACKNOWLEDGEMENTS

This work was supported by the Foundation for Research Development (FRD) and the National Energy Council (NEC) of South Africa joint programme.

REFERENCES

- 1 Boldea I., and Nasar S.A.: "Linear motion electromagnetic systems", J. Wiley & Sons, 1985
- 2 Gieras J.: "Linear induction motor" (in Polish), WNT, Warsaw, 1990